



Riciclaggio cavi elettrici e radiatori - Electric cables and radiators recycling



Riciclaggio RAEE e CAR FLUFF - W.E.E Recycling and CAR FLUFF



Riciclaggio metalli non ferrosi - Non-ferrous metals recycling



Riciclaggio materie plastiche - Plastics recycling



Separazione densimetrica a secco - Dry densimetric separation



Riciclaggio inerti e vetro - Aggregates and glass recycling



proudly made in italy

MACCHINE PER IL RECUPERO DIFFERENZIATO DA SCARTI E SFIDI INDUSTRIALI
MACHINES FOR INDUSTRIAL SCRAPS RECYCLING



www.guidettisrl.com



Via Salvi, 1 | 44045 Renazzo [FE] Italy | Tel. +39 051 6858511 | Fax +39 051 972099 | info@guidettisrl.com

Guidetti s.r.l. si riserva il diritto di apportare modifiche ai prodotti in qualsiasi momento, anche senza preavviso. È vietata la riproduzione, anche parziale, del materiale qui contenuto se non autorizzata.
Guidetti s.r.l. reserves the right to make changes to its products at any time, including without notice. Unauthorised reproduction, including partial, of the contents of this document is forbidden.
Guidetti s.r.l. se réserve le droit de modifier à tout moment les produits, même sans préavis. La reproduction, même partielle, du matériel contenu dans ce manuel est interdite, à moins d'une autorisation préalable.
Guidetti s.r.l. se reserva el derecho a aportar modificaciones a los productos en cualquier momento, incluso sin preaviso. Está prohibida la reproducción, incluso parcial, del material aquí contenido si no ha sido previamente autorizada.
Die Guidetti s.r.l. behält sich vor, jederzeit Änderungen auch ohne Vorankündigung an den Produkten vorzunehmen. Der auch teilweise Nachdruck ohne Genehmigung ist untersagt.

www.guidettisrl.com

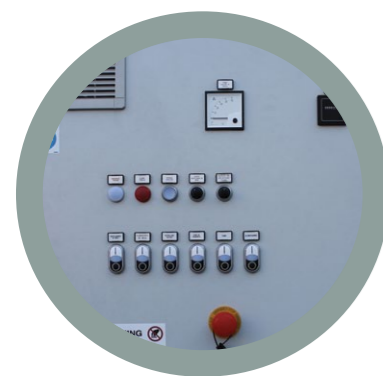

ROBI 151



SEPARATORS Robi

	Dimensioni - Dimensions - Medidas - Außenmaße [mm]									Peso Weight Poids Peso Gewicht	Potenza Installata Installed Power Puissance Installée Potencia Instalada Installierte Leistung	Produzione Production Producción Produktion
	A	B	C	E	F	G	H	I	L			
ROBI 71	1930	1455	2030	877	810	Ø350	Ø250	250	130	830 kg	3,5 kW (4.7 HP)	(*)
ROBI 151	2170	1860	2395	1076	1012	Ø500	Ø350	250	130	1070 kg	5 kW (6.7 HP)	(*)

(*) Variabile a seconda del tipo di materiale trattato. - Changeable according to the kind of processed material. - Variable selon le matériel traité. - Varia según la tipología del material tratado. - Variabel je nach der Typologie des behandelten Materials.

I dati tecnici sono indicativi e possono essere variati a scopo migliorativo senza preavviso. - The technical data are indicative and can be changed without previous notice. - Les données techniques sont indicatives et sujettes à modification sans préavis. - Los datos técnicos son indicativos y pueden variar sin previo aviso. - Die technischen Daten sind unverbindlich und können jederzeit ohne vorherige Ankündigung geändert werden.

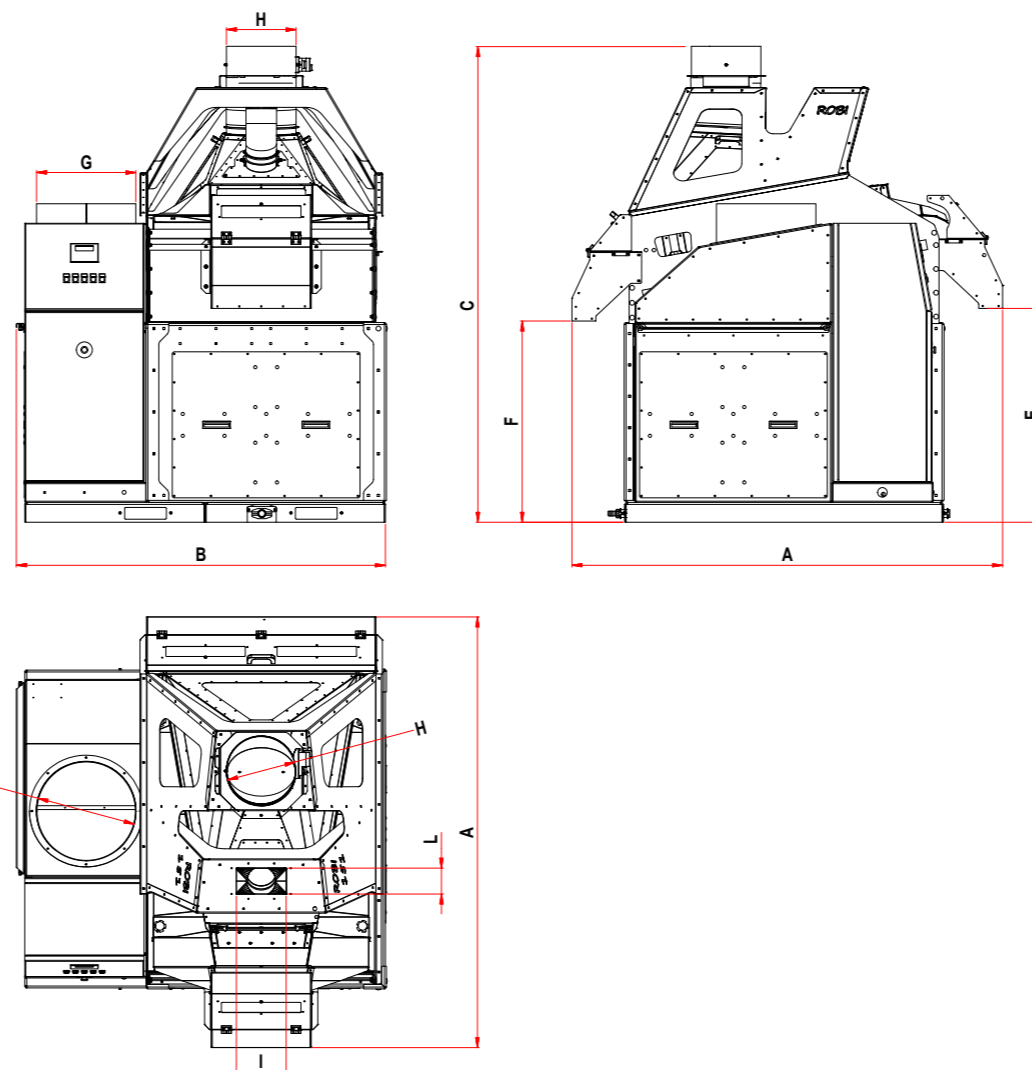

In conformità alle norme CE.
Conform to CE rules.
Conformit CE-regeln.
Conformes aux réglementations CE.
Son conformes a las normas CE.



 I Separatori Guidetti sono stati progettati con lo scopo di dividere materiali granulati, macinati e granaglie di uguale granulometria e diverso peso specifico. Il funzionamento in continuo e l'ampio campo di regolazione con macchina in moto rendono tali separatori adatti ad essere inseriti in impianti di riciclaggio.

Alcuni esempi di utilizzo: * Recupero di metalli da cavi elettrici (separazione tra rame ed alluminio; separazione di rame ed alluminio da PVC o gomma); * Impiego nell'industria delle materie plastiche (separazione di materie plastiche da metalli, sabbia, fibre, sassi, ecc...); * Impiego nell'industria del legno (separazione del legno da metalli, sabbia, pietre, vetro, ecc...).

 The Guidetti separators have been designed to separate granulated materials, ground stuff, and grains having the same particle size but different specific weight. The continuous running and the wide range of adjustment make the separators particularly suitable for their insertion in recycling plants.

Some example of use: * Recovery of metals from electric cables (separation of copper and aluminium; separation of copper or aluminium from PVC or rubber); * Appliance in plastic industries (separation of plastics from metals, sand, stones, fibers, etc...); * Appliance in woodworking industries (separation of wood from metals, sand, stones, glass, etc...).

 Les séparateurs Guidetti ont été conçus pour séparer les produits granulés, broyés et les grains de même granulométrie et de poids spécifique différent. Le fonctionnement en continu et le vaste champ de réglage avec l'appareil en service rendent les séparateurs particulièrement indiqués pour être insérés dans des lignes pour le recyclage.

Quelques exemples d'utilisation: * Récupération de métaux de câbles électriques (séparation du cuivre et de l'aluminium; séparation du cuivre ou de l'aluminium de PVC ou caoutchouc); * emploi dans l'industrie des matières plastiques (séparation des matières plastiques de métaux, sable, cailloux, fibres, etc...); * Emploi dans l'industrie du bois (séparation du bois de métaux, sable, pierres, verre, etc...).

 Los separadores de la serie Guidetti han sido diseñados para dividir metales granulados, molidos y granos con igual granulometría y diferente peso específico. El funcionamiento en continuo y el gran campo de regulación con la máquina en marcha, hacen que estos separadores sean particularmente aptos para instalar en plantas de reciclaje.

Algunos ejemplos de empleo son: * Recuperación de metales de cables eléctricos (separación del cobre y aluminio; separación del cobre ó aluminio del PVC ó goma). Utilización en la industria de materia plásticas (separación de materias plásticas de metales, arena, fibras, piedras, etc...); * Empleo en la industria de madera (separación de la madera de metales, arena, piedras, vidrio, etc...).

 Die Guidetti Abscheider wurden für die Trennung von Granulaten gemahlener Stoffen und Getreiden mit gleicher Korngröße und unterschiedlichem spezifischem Gewicht entwickelt. Diese Anlage ist aufgrund der vielen Einstellungsmöglichkeiten für den Dauerbetrieb geeignet. Durch eine dauerhafte Bearbeitung und diesen vielen Einstellungsmöglichkeiten bei laufender Maschine sind diese Abscheider bestens geeignet für folgenden Einsatz in Recycling-Anlagen.

Einige Anwendungs-Beispiele: * Metallrückführung aus Elektrokabeln (Trennung von Kupfer und Aluminium; Trennung von Kupfer oder Aluminium aus PVC oder Gummi); * Einsatz in der Kunststoffindustrie (Trennung von Kunststoffen aus Metallen, Sand, Fasern usw...); * Einsatz in der Holzindustrie (Trennung von Holz aus Metallen, Sand, Steinen, Glas usw...).

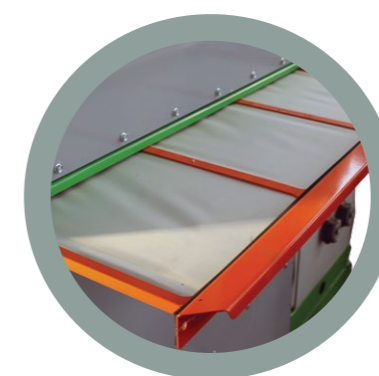

Facile manutenzione.
Easy maintenance.
Entretien facile.
Fácil mantenimiento.
Einfache Wartung.



ROBI 71

